

Dialogannahme

ADAS CALIBRATION

Version 2024.05.18 – Prices on request

2-in-1 XXL calibration board | for VW front camera and multi-brand radar | Q.DAS

2-in-1 XXL calibration board with the pattern for calibrating front camera systems on VW Group vehicles. The newly reworked version in combination with Q.DAS allows users to also calibrate radar systems on all vehicles that require an even reflective service in front of the radar sensor. This enables radar calibration also on vehicles outside the VW Group.

Article number: 8 900 381 056

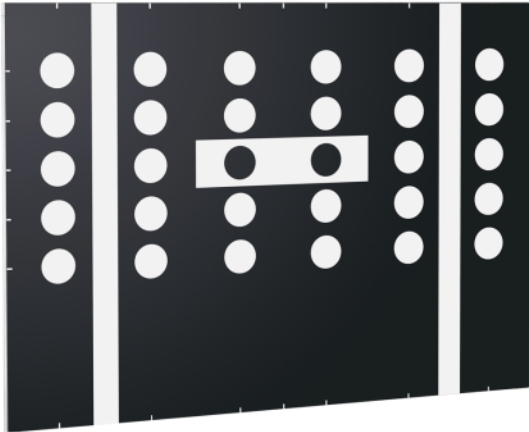

2-in-1 XXL calibration board with the pattern for calibrating front camera systems on VW Group vehicles. The newly reworked version in combination with Q.DAS allows users to also calibrate radar systems on all vehicles that require an even reflective service in front of the radar sensor. This enables radar calibration also on vehicles outside the VW Group. Single and double radar systems can be calibrated in the lowest height position, without any setup times or rotation of the target board. The height is infinitely adjustable to cover both low positioned radar systems as well as high positioned camera systems with only one calibration board. The purchase of the XXL calibration board does not require any further ACC reflector mirrors (8 900 381 150) for radar calibration! The required tilting positions are also possible with the XXL calibration board. Advantages:

- Camera calibration for VW Group vehicles and multi-brand OEM radar calibration in one
- No setup times, no rotation
- For single and double radars
- For passenger cars and transporter (very high transporters may only work in combination with Q.DAS Pro)
- Integrated tilting mechanism with 3 positions
- High quality materials and finishing with flat surface guarantee

Note: Only in combination with the Q.DAS frame.

eTarget Kit | Digital 15-in-1 solution

15-in-1 calibration patterns in one eTarget for faster and error-free target board selection.

Article number: 8 900 380 011

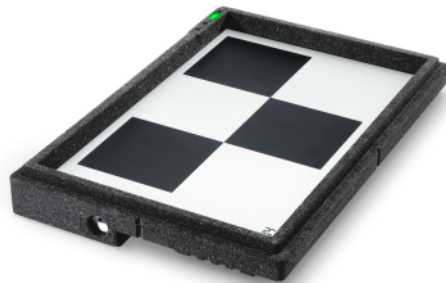

eTarget: fast and space-saving solution for workshops – broad manufacturer coverage includedeTarget is an innovative digital calibration target based on e-paper technology - unlike conventional monitors, beamers or other screen solutions.OEM-compliant calibration targets for precise and fast ADAS calibration with Q.DAS:

- Faster setup times, more space: 15 patterns in one eTarget
- Automatic pattern selection minimizes user errors
- Extremely high contrast, even from different viewing angles
- Reflective technology for all lighting conditions
- Integrated Bluetooth module for app communication
- Lightweight and robust housing
- Downward compatible with previous Beissbarth calibration solutions (BBFAS 1xxx, BBFAS 415)
- Battery operated and power saving – display is maintained even without power

Scope of deliveries:

- 2x eTarget with charging cable
- 1x Universal Type 4S (8 900 382 570)

Note: Automatic target selection requires active license for Q.mApp software.

Multi-Target starter kit 1

For articles to be ordered, see configuration. | Article number: 8 900 381 001



- Multi-Target starter kit 1 with storagebox

Targets included:

- Nissan Set 1 (8 900 381 139)
- Toyota (8 900 382 287)
- Mercedes 1 / Infiniti 2 (8 900 382 312)
- Mazda 1 (8 900 382 318)
- Honda 3 (8 900 382 349)
- Toyota 3 (8 900 382 355)
- Universal Target 1 (8 900 382 570)

Multi-Target starter kit 2

For articles to be ordered, see configuration. | Article number: 8 900 381 002



- Multi-Target starter kit 2 with storagebox

Targets included:

- Mercedes 1 / Infiniti 2 (8 900 382 312)
- Mercedes 2 (8 900 382 319)
- Universal Target 1 (8 900 382 570)

Calibration target set Nissan type 1

Article number: 8 900 381 139

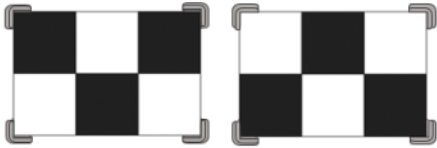

Nissan

- Qashqai [J11] year from 2013 to 2017-09
- Qashqai Facelift [J11] year from 2017-10
- X-Trail / Rouge [T32] Facelift year from 2017

Calibration target set Nissan type 2

Article number: 8 900 381 140

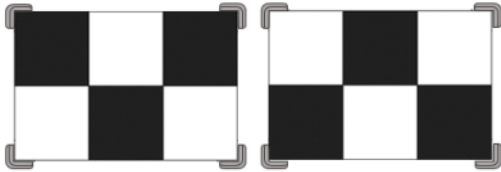

Infiniti

- QX60 formerJX [L50]
- QX70 [Y51] = FX_Serie year from 2013

MERCEDES-BENZ

- X-Klasse [470, 471] year from 2017

Nissan

- Altima [L34] year from 2019
- Leaf [ZE1] year from 2018
- Maxima [A36] year from 2016
- Maxima [A36] year from 2015 to 2016
- Micra [K14] year from 2017
- X-Trail / Rouge [T32] year from 2013 to 2016

Calibration target set Honda type 1

Article number: 8 900 381 143

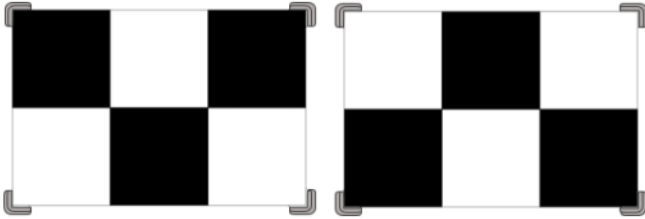

Honda [EU]

- Jazz / Fit [GK] year from 2015
- Civic (9) year from 2012 to 2016
- Civic Typ KG : year from 2016 to 2017
- HR-V [RU] year from 2015

Honda [US]

- Accord US year from 2013 to 2015
- Civic (5 door) year from 2016 to 2017
- Civic (Hybrid) year from 2012 to 2015
- CR-V year from 2017
- HR-V year from 2016 to 2017

Calibration target Honda type 2

Article number: 8 900 382 297



Calibration target Honda type 3

Article number: 8 900 382 349



Honda [EU]

- Accord (9) [CR] year from 2014
- Civic Non KG: year from 2016 to 2017
- CR-V (4) [RM] year from 2012 to 2015
- CR-V (4) [RM] year from 2015 to 2017

Calibration target Mazda type 1

Article number: 8 900 382 318



MAZDA

- CX 3 [DK] year from 2015
- CX 5 [KE] year from 2012 to 2016
- CX 9 [TB]
- MX5 [ND]
- Serie-2 [DJ, DL]
- Series-3 [BM] year from 2013 to 2016-05
- Series-6 [GJ] year to 2016

Calibration target set Mazda type 2

Article number: 8 900 381 234

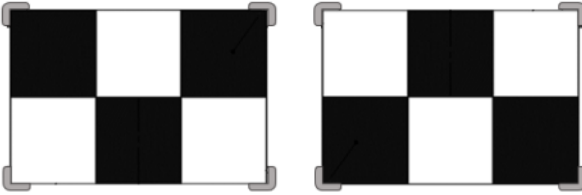

MAZDA

- CX 5 [KF] year from 2017
- Series-3[BN] year from 2016-06
- Series-6 [GL] year from 2017

Calibration target set Mitsubishi type 1

Article number: 8 900 381 218

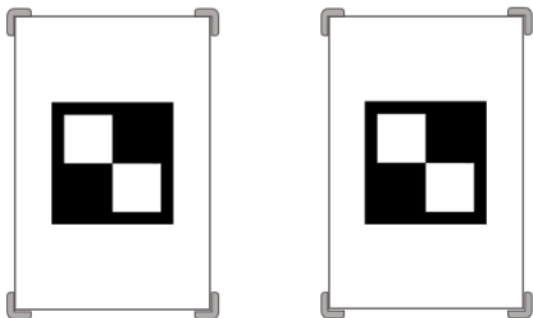

MITSUBISHI

- ASX / Outlander Sport [GA] year from 2018
- Eclipse Cross [GK] year from 2018
- Outlander III Facelift / PHEV year from 2017

Calibration target Toyota type 1

Article number: 8 900 382 287



LEXUS

- ES300h ES450h [V6#] year from 2012 to 2015
- GS-F, GS200t, GS250, GS300h GS350 GS450h [L1#] year from 2012
- LS460, LS600h [F4#] year from 2007
- NX200 NX300h [Z1#]
- RC-F, RC200t, RC350 [C1#] year from 2014

TOYOTA

- Auris / Corolla [E18#] with SafetySense 3-Step year from 2015 to 2018
- Avensis [T27#] with SafetySense 3-Step year from 2015
- Aygo [B4#] with SafetySense 3-Step year from 2015
- Camry [V5#] year from 2014
- C-HR X10/X50 year from 2017
- Highlander, Kluger [U5] year from 2013
- Mirai [JPD10] year from 2015
- Prius [W30] Prius [W40] year from 2009 to 2015
- RAV4 [A4] year from 2012 to 2015
- Verso [R2#] with SafetySense 3-Step year from 2016
- Yaris [P13#] with SafetySense 3-Step year from 2015 to 2017
- Yaris [P13#] with SafetySense 3-Step year from 2017

Calibration target Toyota type 2

Article number: 8 900 382 328



CITROEN

- C1 [B4] year from 2014

PEUGEOT [EU]

- 108 [B3]

TOYOTA

- Auris / Corolla [E18#] with SafetySense 1-Step year from 2015 to 2018
- Avensis [T27#] with SafetySense 1 -Step year from 2015
- Aygo [B4#] with SafetySense 1-Step year from 2015
- Verso [R2#] with SafetySense 1-Step year from 2016
- Yaris [P13#] with SafetySense 1-Step year from 2015 to 2017
- Yaris [P13#] with SafetySense 1-Step year from 2017

Calibration target Toyota type 3

Article number: 8 900 382 355



LEXUS

- ES300h ES450h [V6#] year from 2015
- IS200t IS300h IS350 [E3#]
- LS500h LS600h [F5#] w Mono-Front-Camera year from 2017
- LS500h LS600h [F5#] w Stereo-Front-Camera year from 2017
- LX570 [J20] year from 2007
- RX200t, RX350, RX450h, [L2#] year from 2015-09

TOYOTA

- Hilux_[N12, N13] year from 2015
- Prius [W50] year from 2015
- RAV4 [A4] year from 2015 to 2018

Calibration target Subaru type 2S

With slot for the alignment laser

Article number: 8 900 382 608

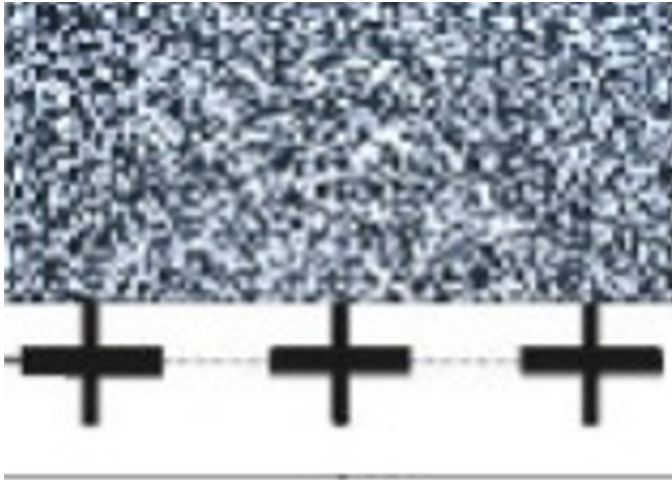

SUBARU

- Forester G3 (AUS), [SH /S13] year from 2012
- Forester G4 (AUS), [SJ] year from 2014
- Impreza G4 (AUS), [GJ,GP/G23] year from 2011 to 2015
- Legacy [BM,BR / B13] year from 2012
- Outback [BR / B14] year from 2012 to 2015
- XV / Crosstrek [GP, G33] year from 2011 to 2015

Calibration target Subaru type 3S

With slot for the alignment laser

Article number: 8 900 382 590



SUBARU

- Impreza G4, [GJ,GP/G13] year from 2011 to 2017
- Impreza G5 , [GK,GT] year from 2018
- Legacy [BN,BS] year from 2014
- Levorg [GP / V10,VM] year from 2014
- Liberty (au) [BN] year from 2014
- Outback [BR / B14] year from 2015
- Outback [BS /B15] year from 2014
- WRX [VA /V10] year from 2014
- XV / Crosstrek [GP, G33] year from 2015

Calibration target Kia / Hyundai type 2

Article number: 8 900 382 320

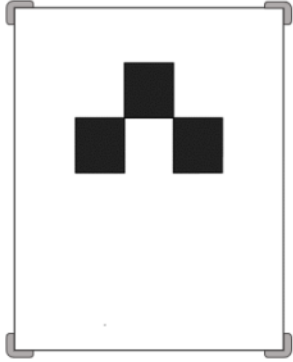

Hyundai

- H350 [EU] year from 2015

Calibration target Kia / Hyundai type 3

Article number: 8 900 382 316



Hyundai

- Equus [VI] year from 2016
- Genesis [BH] year from 2011 to 2014
- SantaFe [DM] Grand-SantaFe [NC] Sport-SantaFe MaxCruise [NC] year from 2015

KIA

- Cadenza / K7 [VG] year from 2009 to 2016
- Sorento [XM] year from 2009 to 2015

Calibration target Mercedes/Infinity type 1

Calibration target for Mercedes (passenger cars)

Article number: 8 900 382 312



MERCEDES-BENZ

- A-Klasse [176] year from 2012 to 2018
- B-Klasse [246] year from 2011-11 to 2018-11
- C-Klasse [204] +Facelift year from 2007 to 2014
- C-Klasse [205] year from 2014
- CL [216] year from 2006 to 2013
- CLA [117] year from 2013 to 2019
- CLS [218] year from 2011 to 2018
- E-Klasse [212] year from 2012 to 2016
- E-Klasse [213] year from 2016
- E-Klasse Coupe [207] year from 2009 to 2016
- E-Klasse Coupe [238] year from 2016
- GLA [156] year from 2013 to 156]
- GLC [253] year from 2015
- GLE [292] year from 2015 to 2019
- GLK [204] + Facelift year from 2008 to 2015
- M-Klasse (GL-Klasse) GLE, GLS [166] Camera system 4.0.1 year from 2011 to 2015
- M-Klasse (GL-Klasse) GLE, GLS [166] Camera system 4.0 year from 2011 to 2015
- M-Klasse [GL-Klasse] [164] year from 2006 to 2012
- S-Klasse [221] year from 2005 to 2013
- S-Klasse [222] year from 2013
- S-Klasse Coupe [217] year from 2014 to 217]
- SLK, SLC [172] year from 2011
- SL-Klasse [231] year from 2012
- SLR [190] year from 2014 to 2016
- V-Klasse[447] / Vito [448] year from 2014

Calibration target Mercedes / Infinity type 2

Calibration target for Mercedes (Sprinter) / Infinity

Article number: 8 900 382 319

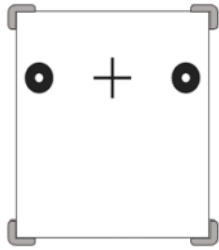

MERCEDES-BENZ

- Sprinter [W909] year from 2013 to 2019
- Sprinter 2500 / 3500 [W906] year from 2006 to 2013

VOLKSWAGEN

- Crafter [2E,2F] year from 2016 to 2017

Calibration target Universal type 6S

With slot for the alignment laser

Article number: 8 900 382 571



CITROEN

- C3 Aircross [A88] year from 2017
- DS3 Crossback [D34] year from 2019
- DS7 Crossback [X74] year from 2017
- Jumper 3 / Relay 3 [U9] year from 2014

FIAT

- 500X [334] year from 2015
- Ducato year from 2014

Hyundai

- Elantra [ADA] year from 2017
- Genesis [DH] year from 2014
- i10 [IA] year from 2017
- i20, i20 Active [GB] year from 2015
- i30 [GD] year from 2015
- i30 [PDE] year from 2017
- i40 [VF] year from 2012
- IONIQ [AE-HEV] year from 2017
- SantaFe[DM] year from 2016
- Sonata [LFA] year from 2016
- Tucson [TL] year from 2016

Jeep

- Renegade [BU] year from 2015

KIA

- Cadenza / K7 [YG] year from 2016
- Carens / Rondo [RP] year from 2014
- Ceed / Pro Ceed [JD] year from 2013
- Niro [DE] E-Niro year from 2017
- Optima [JF] year from 2016

- Optima [TF] year from 2015
- Rio (YB) year from 2017
- Sorento [UM] year from 2015
- Soul [PS] E-Soul year from 2015

OPEL

- Crossland X year from 2017
- Grandland X year from 2018

PEUGEOT [EU]

- 3008 II year from 2018
- 508 II year from 2018
- Boxer-3 / Manager [U9]

TESLA

- Model S year from 2016-10
- Model X year from 2016-10

Calibration target set Universal type 2

Article number: 8 900 381 142

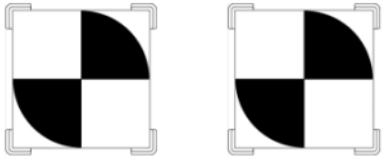

NISSAN

- Cima; Fuga [Y51] = Infinity Q70
- NV400 [X62]
- Patrol [Y62] year from 2010

OPEL

- Movano-B

RENAULT

- (Grand) Espace V [xFC] year from 2015
- (Grand) Scenic III [J95] year from 2012
- Kadjar [HL/ HZH, HFE] year from 2015 to 2018
- Koleos II [HZG, HZJ] year from 2016
- Master III [x62] year from 2010
- Megane III [x95] year from 2008
- Megane IV [xFB] year from 2016
- Talisman [xFD] year from 2015
- Twingo III [B07] year from 2014

SMART

- ForFour [543.0] year from 2014
- ForTwo [543-3-4] year from 2014

Target storage box empty

Article number: 1 690 381 217



- Empty storagebox for storing the multi brand targets for front camera calibration.

ACC reflector mirror | for radar calibration

ACC reflector mirror for adjusting the ACC sensor.

Article number: 8 900 381 150

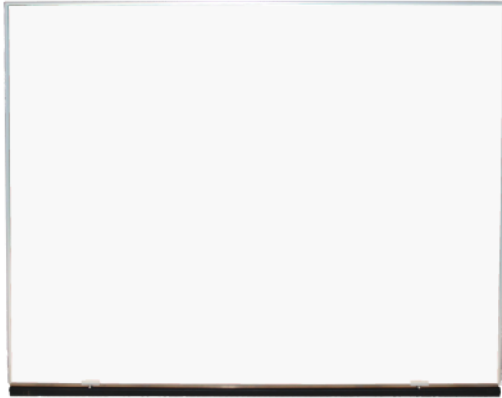

BBFAS 1415

Article number: 8 900 380 007

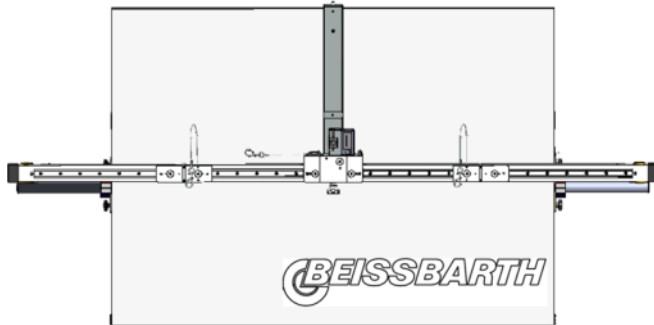

- Comprehensive coverage of the front camera calibration will be achieved by upgrading the system with the BBFAS 1415. In combination with the optional calibration targets the service can be extended for all important European, Japanese and Korean vehicle manufacturers.
- You simply need to mount the precision measurement bar, which is able to carry the calibration targets, on the BBFAS 1000 base frame and you are ready to go. Precise orientation of the frame and the target relative to the driving axle is made possible with the Beissbarth 3D wheel alignment system or with Beissbarth CCD system.

Target Shop

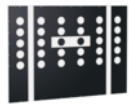

2-in-1 XXL calibration board | for VW front camera and multi-brand radar | Q.DAS

Article number: 8 900 381 056



eTarget Kit | Digital 15-in-1 solution

Article number: 8 900 380 011



Multi-Target starter kit 1

Article number: 8 900 381 001

For articles to be ordered, see configuration.



Multi-Target starter kit 2

Article number: 8 900 381 002

For articles to be ordered, see configuration.



Calibration target set Nissan type 1

Article number: 8 900 381 139



Calibration target set Nissan type 2

Article number: 8 900 381 140



Calibration target set Honda type 1

Article number: 8 900 381 143



Calibration target Honda type 2

Article number: 8 900 382 297



Calibration target Honda type 3

Article number: 8 900 382 349



Calibration target Mazda type 1

Article number: 8 900 382 318



Calibration target set Mazda type 2

Article number: 8 900 381 234

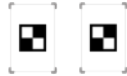

Calibration target set Mitsubishi type 1

Article number: 8 900 381 218



Calibration target Toyota type 1

Article number: 8 900 382 287



Calibration target Toyota type 2

Article number: 8 900 382 328



Calibration target Toyota type 3

Article number: 8 900 382 355

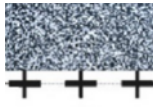

Calibration target Subaru type 2S

Article number: 8 900 382 608

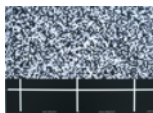

Calibration target Subaru type 3S

Article number: 8 900 382 590



Calibration target Kia / Hyundai type 2

Article number: 8 900 382 320



Calibration target Kia / Hyundai type 3

Article number: 8 900 382 316



Calibration target Mercedes/Infiniti type 1

Article number: 8 900 382 312



Calibration target Mercedes / Infiniti type 2

Article number: 8 900 382 319



Calibration target Universal type 6S

Article number: 8 900 382 571



Calibration target set Universal type 2

Article number: 8 900 381 142



Target storage box empty

Article number: 1 690 381 217



ACC reflector mirror | for radar calibration

Article number: 8 900 381 150



BBFAS 1415

Article number: 8 900 380 007

IMPORTANT NOTES

- Please notice: This list contains spare parts, too.
- Without instruction or assembly.
- Delivery ex works including packaging.

VERSION 2024.05.18 – PRICES ON REQUEST

- Starting from now all previous lists will lose their validity.
- Please read our general terms and conditions in the latest version before ordering; to be found under www.beissbarth.com.

Order number 1 693 602 008 **Print norm** BB XXX / XX.XX.2020 DE · Subject to technical and program changes, errors excepted.

Beissbarth Automotive Testing Solutions GmbH

Hanauer Straße 101
80993 Munich, Germany
sales@beissbarth.com
www.beissbarth.com

Telefon: +49-(0)89-14901-0
Telefax: +49-(0)89-14901-246

